

# 1T8415DA | CTEVO WALL WASHER 105

## Recessed LED Downlight in a trim version

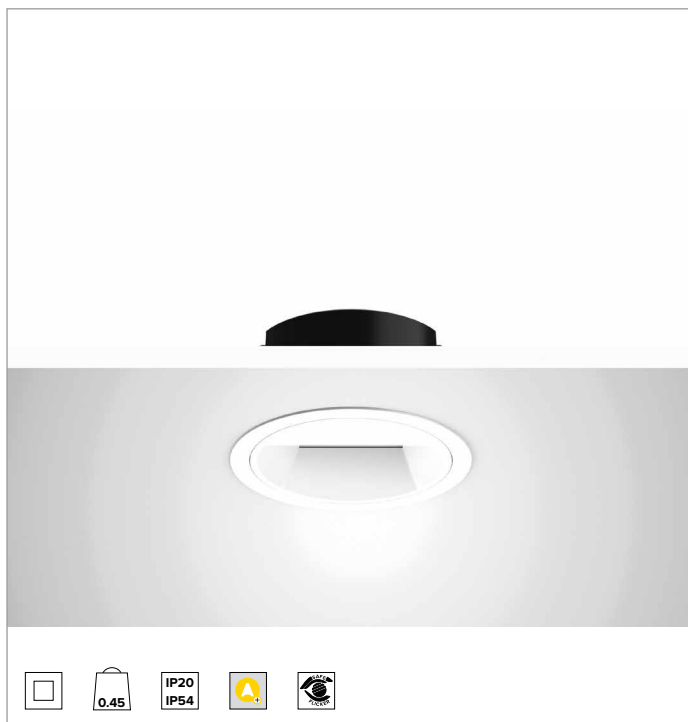

		2700K	H(m)	D1(m)	D2(m)	E <sub>max</sub> (lx)	
		Ra90	43°	76°			
Fixture Power	18W	1	0.86	1.66	912		
Source Flux	1934lm	2	1.72	3.31	228		
Fixture Flux	1094lm	3	2.58	4.97	101		
Efficacy	60lm/W	4	3.44	6.62	57		
TS1395	I <sub>max</sub> =540cd/klm	I <sub>max</sub>	1044cd	5	4.30	8.28	36

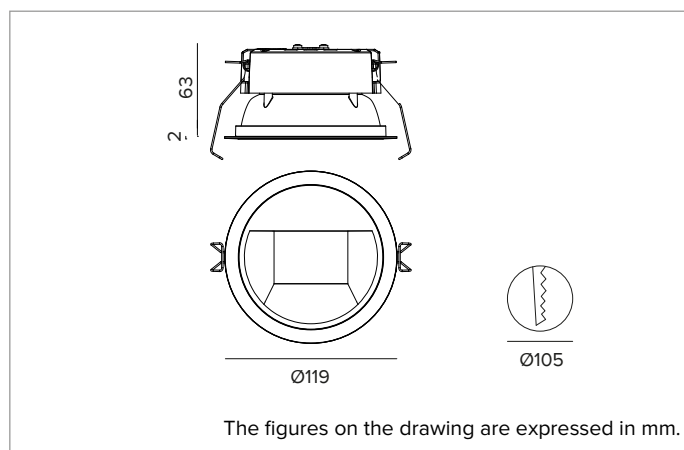

### SOURCE

High efficiency Chip on Board LED Ra90. Ra80 on request.

**Energy efficiency class:** E

**Nominal power:** 16W

**Nominal flux:** 1934lm

**Colour rendering index:** 90

**Rf:** 92

**Rg:** 99

**CCT nominal:** 2700K

**Lifetime (L80/B10):** >50000h tq +25°C

### ILLUMINOTECHNICAL CHARACTERISTICS

WW Optic: a highly reflective pre-anodised aluminium asymmetric reflector, a holographic acrylic diffuser screen and thermoplastic load-bearing elements.

**Optic:** WALL WASHER

**Optical efficiency:** 57%

**Fixture flux:** 1094lm

**Luminous efficacy:** 60lm/W

**Photobiological safety:** Compliant with RG1 low risk group

### MECHANICAL CHARACTERISTICS

Die-cast black painted anodised aluminium heat sink. Black thermoplastic material structure and a white painted cut-off front. Silicone sealing kit for water and dust protection. Trim version with an integrated white ring.

**Colour and finish:** Plaster white

**Weight:** 0.45Kg

**Version:** TRIM

**Degree of protection:** IP20 for recessed part

**Degree of protection:** IP54 for exposed part

### ELECTRICAL CHARACTERISTICS

Integrated DALI driver. Luminaire compliant with EN 60598-2-22 for power supply from a centralised emergency system CPSS (Central Power Supply System), not incorporated in the luminaire - high risk areas excluded. The default power and flux are 100% in AC and 100% in DC.

**Fixture Power:** 18W

**Power supply:** 220-240Vac 50/60Hz

**Insulation Class:** CLASS 2

**Type of driver / Control:** DALI

**Driver included:** YES

**Class F:** YES

**SAFE FLICKER:** PstLM=<1 and SVM=<0.4 (IEC TR 61547-1 and IEC TR 63158), to ensure a more comfortable and safe light

**Ambient temperature:** 0°C / +25°C

### INSTALLATION

Quick tool-free mounting system for false ceiling installation from 0.5 to 30mm.

### NOTES

Casambi control system available using a dedicated accessory. 110-277Vac version available on request. Commissioning of the control system via free APP; the intervention of a specialist technician can be quoted on request.

### WARRANTY

5 years.

### WARNING

Luminaire designed for disposal/recycling at end-of-life. Replaceable (LED only) light source by a professional. Replaceable control gear by a professional.

*Due to the technological evolution of the electronic components, the data provided may be updated, and as such, confirmation must be requested during the order process.*

*Luminous flux and power supply have +/-10% tolerances with respect to the indicated value. tq +25°C (CIE 121).*

*We reserve the right to make technical changes.*

Targetti Sankey S.r.l.  
Via Pratese, 164  
50145 Firenze - Italy  
Tel: +39 055 37911  
targetti.com  
targetti@targetti.com

CCIAA Firenze  
Share Capital:  
€ 500.000,00  
VAT N. (IT):  
01537660480  
R.E.A: FI-275656

**TARGETTI**

# 1T8415DA | CCTEVO WALL WASHER 105

## Recessed LED Downlight in a trim version

### Accessories

#### Mounting System



L mm	Code
2500	<b>1T9606</b>

Anti-fall safety cable to secure the body of the appliance to the building structure.

#### Control systems



Code

**1T5349**

IP20 wireless control unit with DALI interface.  
It generates a local DALI2 bus, enabling a direct connection to a DALI interface LED driver.  
The module can only be used in a closed system and cannot be connected to an existing DALI network.  
The module is wireless controlled using a Casambi app for smartphones and tablets using Bluetooth 5.0 technology.  
The devices automatically create an adaptive, robust, and reliable wireless mesh network, allowing for the easy and efficient management of a high number of fixtures.  
The control unit is preset to the DALI 1CH profile, meaning the device can control a single DALI driver with broadcast commands.  
In addition to the DALI broadcast, other operating modes are available, such as:

- Button (normally open)
- Control unit 0/1-10V
- Control unit DALI Tunable White DT8
- Presence sensor



Code

**2T0131**

IP20 Extender for wireless control of LED driver with dimming DALI (or 1-10V) interface based on Casambi technology.  
It has a DALI2 output with the capacity to control up to 40 lighting fixtures.  
With the addition of a further external BUS DALI power supply it is possible to control up to 64 fixtures.  
IP20 Extender is preset to the DALI broadcast profile, meaning all the luminaires connected to it are dimmable at the same level.  
In addition to the DALI broadcast other operating modes are available, such as:

- EXTENDER DALI 8CH
- EXTENDER DALI Tunable White
- EXTENDER 0/1-10V
- EXTENDER DALI 4CH
- EXTENDER DALI DT8 Tunable White

Due to the technological evolution of the electronic components, the data provided may be updated, and as such, confirmation must be requested during the order process.  
Luminous flux and power supply have +/-10% tolerances with respect to the indicated value. tq +25°C (CIE 121).

We reserve the right to make technical changes.

Targetti Sankey S.r.l.  
Via Pratese, 164  
50145 Firenze - Italy  
Tel: +39 055 37911  
targetti.com  
targetti@targetti.com

CCIAA Firenze  
Share Capital:  
€ 500.000,00  
VAT N. (IT):  
01537660480  
R.E.A.: FI-275656

**TARGETTI**